

DTA Transfer: BSME and General Engineering – Mechanical Concentration 2019-20

Entering with an SPU approved DTA
Courses equivalent to the following SPU classes

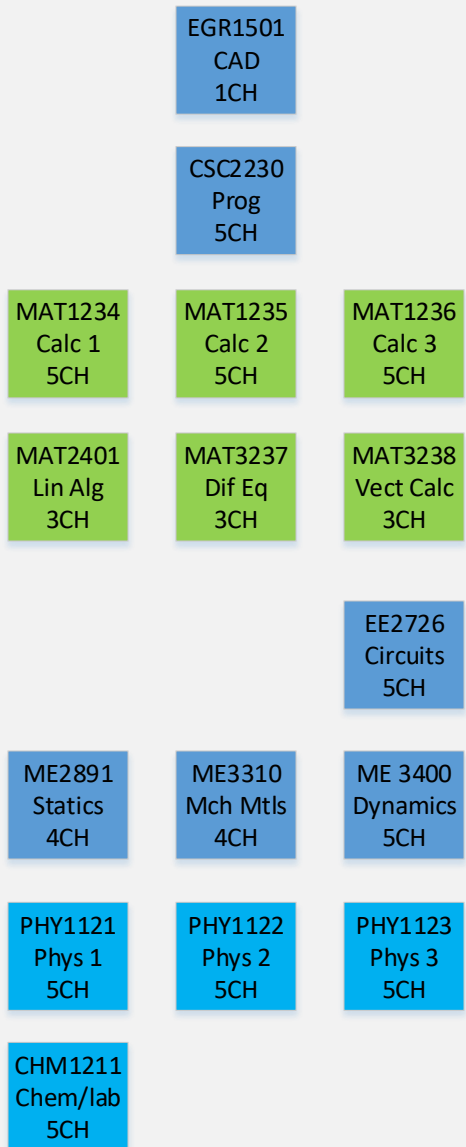

SPU Year 1

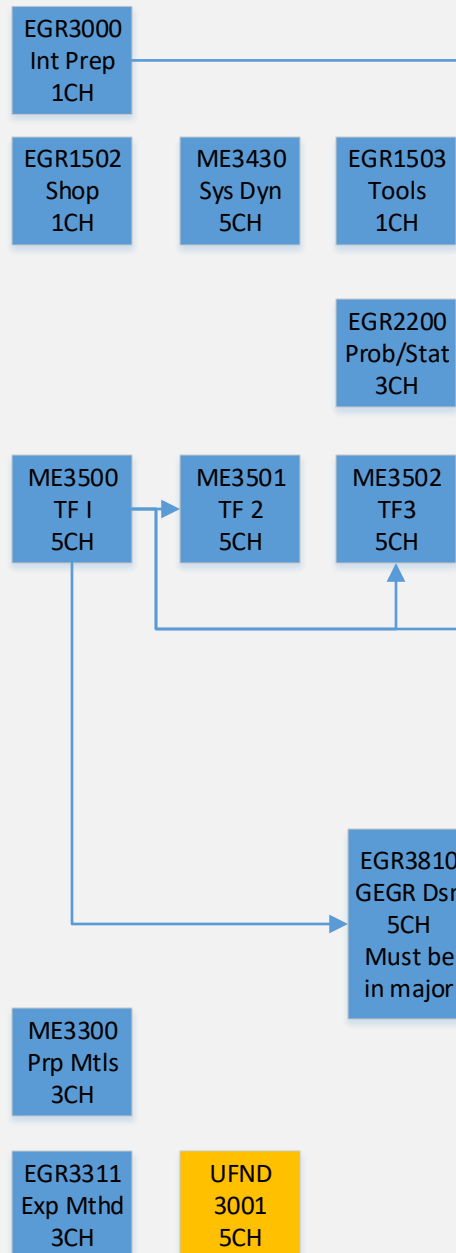

SPU Year 2

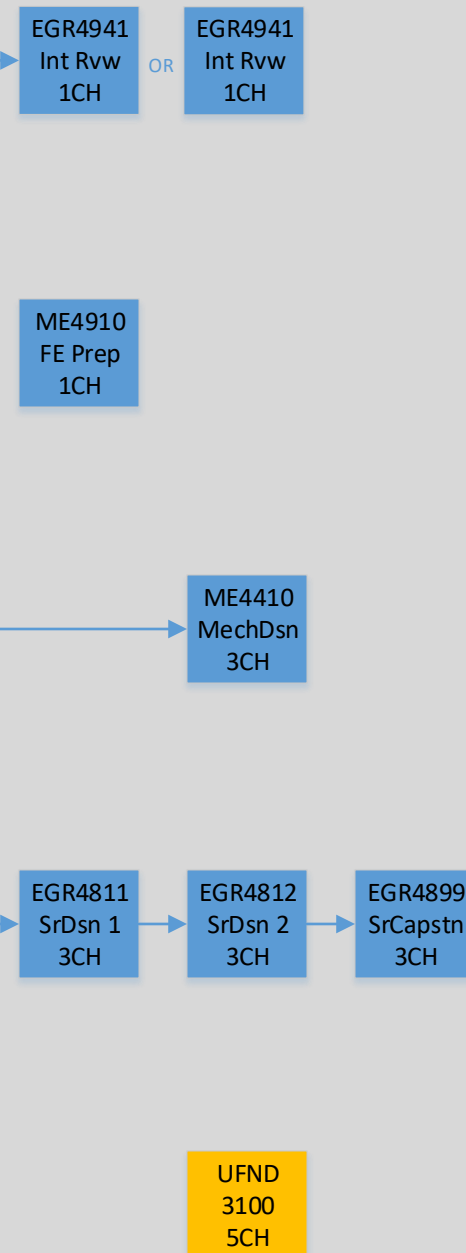

Tech Elective (12CH Total Req)

Tech Elective (12CH Total Req)